



For Earth, For Life
Kubota

SVL

KUBOTA COMPACT TRACK LOADER SVL97-3

Kubota performance, comfort and reliability allow you to work faster, longer and more efficiently.



*This information is sourced from overseas and may not necessarily apply locally. It is essential that you confirm specifications and other information with your local Kubota dealer.





What do you want? More productivity, more comfort, and less downtime!

You've got it. Here's the Compact Track Loader you've been waiting for.

With a new hydraulic system and innovative features, the SVL97-3 delivers what the crowd wants.

- **OUTSTANDING PERFORMANCE AND PRODUCTIVITY**
- **SPACIOUS AND COMFORTABLE WORKSPACE**
- **ADVANCED MULTIFUNCTION OPERABILITY**
- **SIMPLE SERVICEABILITY**

COMPACT TRACK LOADER

SVL97-3

Engine gross horsepower (SAE J 1995): 96.4 HP (71.9 kW)

Rated operating capacity (35% of tipping load): 1569 kg

Rated operating capacity (50% of tipping load): 2242 kg

Bucket breakout force: 3468 kg

Operating weight (Closed Cab, Including operator weight 75 kg): 5411 kg

Powerful Hydraulic System

Load Sensing System

The Load Sensing System and exceptional control valve provide the pushing and driving force you need, even during simultaneous attachment operation. Plenty of power to travel on slopes and handle attachments means you'll get the job done faster.

Adjustable Maximum Oil Flow Control

Maximum AUX flow can be set from the touch panel and is based on your attachment, which ensures the optimal flow rate for every job you do. The attachment icon will help you to identify which preset is for which attachment.

Electronic Travel Torque Management

The Electronic Travel Torque Management System lets you work faster with more power. The ECU constantly monitors the load of the machine to optimize hydraulic pump output for smoother operation that keeps the engine running to get the job done.

Hydraulic Pilot Control

This helps ensure consistent oil flow, allowing for smooth and dependable operator control and stability.

Shock Reduction During Operation

Smoothly shifts gears for smooth start-ups.

-3 SERIES STYLE KUBOTA PRODUCT

The SVL97-3 is ready to take on any job with its new hydraulic system, reliable Kubota engine, impressive travel performance, and efficient cooling system.

Traveling Features

Kubota Shockless Ride (KSR)

Kubota's ride control system (KSR) is now available for Kubota CTLs! It is a loader suspension that enhances comfortability and reduces spilling loads on rough terrain.

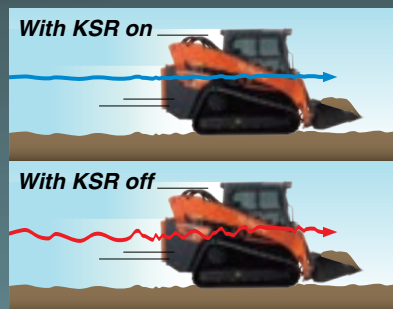

Faster Two-speed Travel

Shift from low gear at 8.9 km/h (0.9 km/h faster than the SVL97-2) to high gear at 13.5 km/h (1.8 km/h faster) to get the job done quicker.

Auto-Shift

Auto shift allows machines to smoothly drive into large piles or push heavy loads and gives outstanding turning performance. The ECU is constantly monitoring the traction load. When the traction load gets high, but before the machine starts to lose traction, it automatically shifts down for better low-range torque. Once the traction load is eased, it shifts back up automatically for high speed. Now you can just leave it in high speed regardless of the work!



Track Response

Operators can now change the sensitivity of their machine control response through the LCD panel. The SVL97-3 offers you a choice of three track response settings: Mild, Normal, and Quick.

Built for Performance

High Hinge Pin Height

The loader arm is designed to reach 3264 mm (hinge pin height) making it easy to dump into almost any truck or trailer.



High-flow Hydraulics

Having high flow increases the hydraulic muscle for attachments that need more hydraulic horsepower. With this auxiliary hydraulic flow increases to 156 l/min. The coupler manifold has both 1/2" and 3/4" couplers.



Standard Self-leveling Function

This feature helps keep the bucket or fork in a horizontal position without manual adjustment while lifting. (It can be turned on or off with the click of a button.)

**Feature only works on the way up while lifting, not while lowering.*

TIVITY



Kubota Engine

New Kubota Engine (Higher Maximum Torque)

A reliable 96.4 HP* Kubota engine provides power for most any job site task. New engine complies with Tier V emissions.

** Engine HP Gross (SAE J1995)*

Common Rail System

The Common Rail System (CRS) electronically controls the fuel injection timing to optimize the fuel consumption.

Auto Idling System

The SVL97-3 will shift to idle when the machine is not in use. Reduce engine RPM instinctively when high engine speed isn't needed. Move any control lever and the engine RPM immediately returns.

SPACIOUS OPERATOR SPACE AND COMFORT

New Cab and technologies, and improved A/C Performance make working in the most demanding conditions a breeze.



One-Piece Sealed and Pressurized Cab

The new one piece cab helps prevent dirt, dust, rain, and other debris from entering the operator space. Furthermore, noise is kept down² to let you work for long hours with minimal fatigue.

²Based on ISO10263 comparison with the previous model.



New one-piece type



Conventional type

Heated Air Suspension Seat

Seat air suspension provides a comfortable ride that reduces fatigue during long workdays. Seat comes standard with heat, improving comfort on cold days.

Sliding Front Door

Kubota's traditional slide up front door can be opened regardless of the position of the bucket or loader arms. This allows for machine operation with the door open if desired.

Wide Cab Entrance

A wide entrance makes it easier to get in and out.

Spacious Interior

The spacious interior provides plenty of foot and elbow room and minimizes operator fatigue, even during long work hours.

LED Work Lights (Front and Rear)

LED lights allow you to work through the night or in the darkest building.

Forward Roof Window

The large roof window allows for outstanding upward visibility when dumping into containers, trucks or trailers.

Improved HVAC Performance^{*1}

Airflow has been improved for outstanding cooling and heating performance regardless of the temperature outside.

^{*1}Based on comparison with the previous model.



RATOR ROOM

Technology

Color LCD Touchscreen with Jog Dial

The SVL97-3's color LCD touchscreen displays a wide range of functions to keep you in tune with the machine. This new screen features touch and jog dial controls and easy-to-read machine vital signs and alerts. It is positioned to the front right of the operator for excellent visibility and easy access.

Attachment Performance Monitor*³

SVL97-3 has a feature to monitor AUX pressure level (PSI) on the LCD touchscreen. It helps to operate attachment based on the pressure level. The monitor will change when AUX is turned on.



³High flow only



- A.** Machine Status (Shows enabled functions and alerts)
- B.** Hydraulic Oil Temperature
- C.** Coolant Temperature
- D.** AUX Mode
- E.** Fuel Level
- F.** DEF level
- G.** Menu Icons



Rear View Camera

The standard rearview camera displays on the touchscreen allows for better rearward visibility on the job site. The rear view can be set to display continuously or only when in reverse.



Keyless Engine Start

The engine can be started by entering a 4-digit passcode on the LCD touchscreen and can store up to 51 individual user passwords. Lost keys are a thing of the past!



Radio with Bluetooth

Our new integrated bluetooth radio allows for seamless bluetooth streaming and hands free calling.

MAINTENANCE

Enhanced engine access speeds up and simplifies routine maintenance.

New Swing-out Radiator

With the radiator out of the way, engine bay access is opened up for maintenance or clean out.

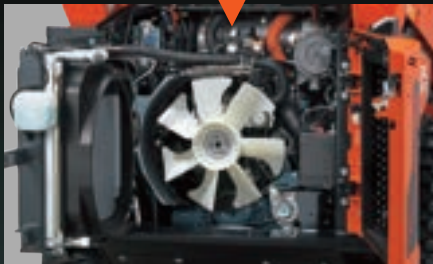
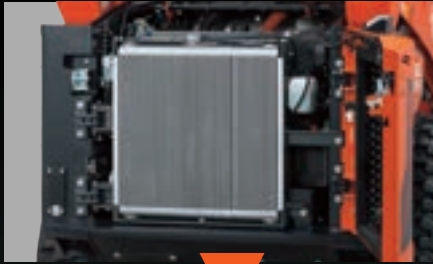

- A. SCR Muffler
- B. Coolant Tank
- C. Radiator
- D. Dual Element Air Cleaner
- E. Battery

Welded Mainframe and Under Carriage

1. Welded, Integrated Mainframe and Undercarriage

The undercarriage forms an integral part of the main frame for maximum durability.

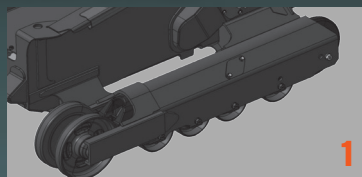

2. Kubota Original Rubber Tracks

Kubota's original rubber tracks offer outstanding durability. Furthermore, Kubota's original lug pattern helps prevent soil from accumulating and helps improve traction force.



3. Triple Flange Lower Track Rollers

A reliable triple flange design helps minimize the chance of detracking and helps improve stability. They are sealed and kept lubricated.

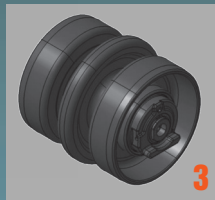

Tilt-up Cabin

The cab can be tilted 72° allowing easy access to the hydraulic pumps, valves, lines and hydraulic tank.



SIMPLIFIED



Engine Equipment and Features

1. Pre-cleaner

Removes dust and dirt from the air prior to reaching the air filter.



2. DEF Tank Cap

The DEF tank has been equipped with a lockable cover to prevent diesel fuel from mistakenly being poured into the tank.



3. Fuel Fill Indicator

When refilling fuel, DEF, or hydraulic oil, a buzzer sounds to prevent overfilling and the potential hazards from fuel spills.



4. Side Window for Cleaning

Side panel can be removed easily and it makes easy access for removing debris inside the arm.

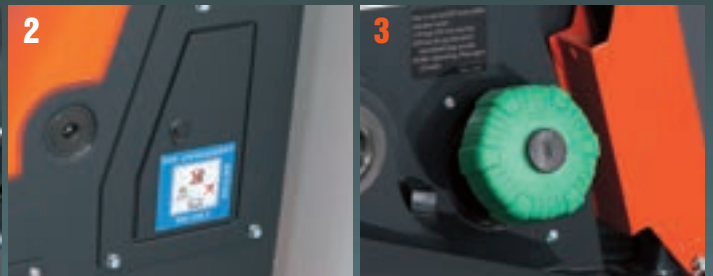

COMFORT MEETS CONVENIENCE



Multi-function Levers

The multi-function levers provide fingertip control of all major vehicle and attachment operations, letting you keep both hands on the levers at all times for optimal operating efficiency.

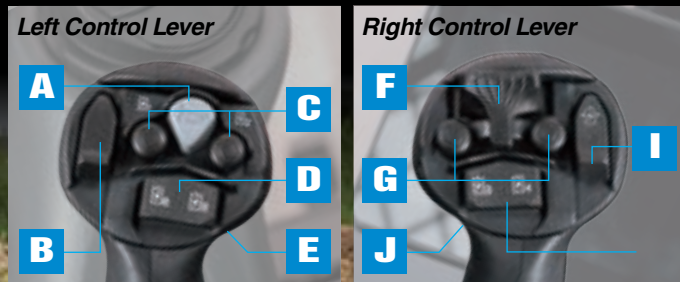

- A. Horn
- B. -Not used-
- C. AUX1
- D. AUX3
- E. Travel Speed

- F. Proportional AUX Switch
- G. AUX Hold Switch
- H. AUX2
- I. AUX Mode Change
- J. Float Switch

New Jog Dial and Switches

The jog dial and switches are well laid out and intuitively labeled. Panel is back lit making it easy to find the button you need in dark conditions.



- A. Home switch
- B. Return switch
- C. Jog dial
- D. Self leveling switch
- E. Working light switch
- F. Beacon light (Opt.) switch
- G. Washer switch (Closed Cab only)
- H. Hydraulic unlock switch
- I. Parking brake switch
- J. AUX port switch
- K. Wiper switch (Closed Cab only)

New Deceleration Pedal Feature

Depending on your work, the foot throttle can now turn into a deceleration pedal with the click of a switch.



ATTACHMENTS

The SVL97-3 Compact Track Loader can connect to a variety of attachments, letting you take on a wide and diverse range of tasks.

**Not all attachments are OEM-KUBOTA.*



■ Auger



■ Pallet Forks

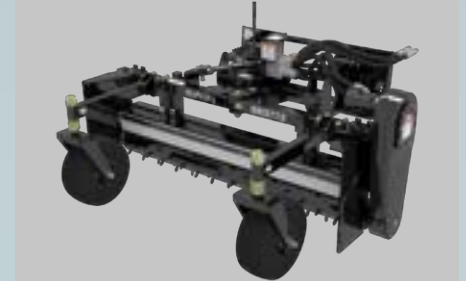

■ Power Rake



■ Skid Grader



■ Rotary Cutter



■ Tiller



■ Box Blade



■ Trencher



■ Hopper Broom

■ Skid Cutter

■ Dozer Blade

■ Loader Broom

■ Powered Rake

■ Broom

■ Auger Drive

■ Skid Tiller

■ Cold Planer

■ Box Blade

■ Polycarbonate Door (Option)

The polycarbonate door is available as an optional kit and is recommended for some attachments.

EQUIPMENT

STANDARD EQUIPMENT

- Closed CAB (w/ air conditioning)
- Top / Rear window
- Air ride, Air suspension with heated seat
- Kubota Shockless Ride (KSR)
- 2" Retractable seat belt
- Operator presence control
- Pull down arm rest
- Hand/Dial and Foot throttle
- Decelerator Pedal
- Keyless engine start
- USB port
- Radio with Bluetooth (Closed CAB)
- 12V electric outlet
- Horn
- Lockable fuel cap
- Rear-view Camera
- Backup alarm
- Rear view mirror
- Working Lights (LED)
- High-flow hydraulics (1/2" and 3/4" couplers for both models)
- Multi-function levers

- Adjustable maximum oil flow
- 14-pin coupler for attachments
- Hydraulic quick coupler
- Loader arm float function
- Bucket self-leveling (up only)
- Wet disc parking brakes
- Two-speed travel
- Rubber crawler 450mm

OPTIONAL EQUIPMENT

- 3" Retractable seat belt
- Polycarbonate door
- Additional counterweight
- Rear bonnet lock Kit
- Strobe light
- Beacon light
- Radiator screen
- Oil Cooler
- ...and much more.

Specifications

Model		SVL97-3 Australia	
Engine	Model		V3800-TIE5-L
	Output (SAE J1995 gross)		HP (kW) / rpm 96.4 (71.9) / 2500
	Output (SAE J1349 net)		HP (kW) / rpm 94.9 (70.8) / 2500
	Displacement		cc 3769
	Cylinders		4
	Bore × Stroke		mm 100 × 120
Aspiration		Turbocharged	
Loader performance	Rated operating capacity-35% tipping load		kg 1569
	Rated operating capacity-50% tipping load		kg 2242
	Tipping load		kg 4483
	Breakout force	Bucket	kg 3468
		Lift arm	kg 2394
Lift arm path		Vertical	
Undercarriage	Track width	Standard	mm 450
	Ground pressure	Standard	psi 4.7 / 4.8
	Track rollers (per side)		5
	Travel speed	Low	km/h 8.9
		High	km/h 13.5
Traction force		kgf 5976	
Hydraulic system	Aux. hydraulic flow		ℓ/min. 90 / 156
	Aux. hydraulic pressure	Std. / High flow	kgf/cm ² 24.5
Service refill capacities	Hydraulic system		ℓ 40.2
	Fuel tank		ℓ 115.7
	DEF tank		ℓ 12.7
Operating weight (Includes operator weight 75 kg)		kg 5411	

The company reserves the right to change the above specifications without notice. This brochure is for descriptive purposes only. Please contact your local Kubota dealer for warranty information. For your safety, Kubota strongly recommends the use of a Rollover Protective Structure (ROPS) and seat belt in almost all applications.

Dimensions

A	Length of track on ground	mm	1667
B	Track gauge	mm	1512
C	Length w/o bucket	mm	3141
D	Length w/bucket on ground	mm	3901
E	Height to top of cab	mm	2112
F	Bucket hinge pin height at max. lift	mm	3264
G	Rollback angle at carry position	degree	28
H	Reach at max. lift and dump	mm	1034
I	Ground clearance	mm	278
J	Departure angle	degree	30.6
K	Max. dump angle	degree	43
L	Vehicle width standard track	mm	1962
M	Width with bucket	mm	2057
N	Turning radius from center-machine rear	mm	1618

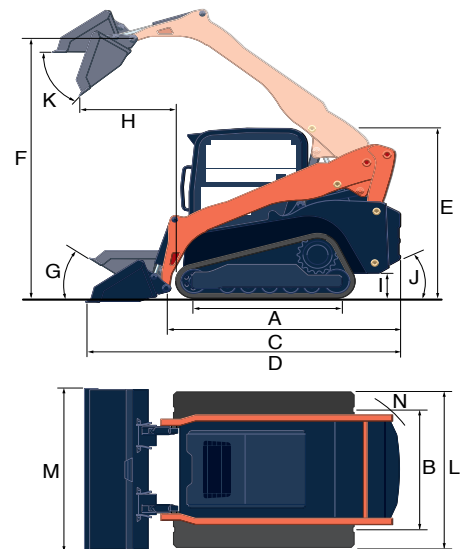

©2024 Kubota Corporation

Kubota Australia Pty Ltd

25-29 Permas Way, Truganina VIC, 3029 Australia
 Freecall: 1800-334-653
 Email: sales@kubota.com.au

Web Site: <http://www.kubota.com.au>

Kubota New Zealand Limited

433 Rangitikei Street, Cloverlea, Palmerston North, 4412 New Zealand
 Freecall: 0800-582-682
 Email: sales@kubota.com.au

Web Site: <http://www.kubota.co.nz>

Kubota Genuine Parts

for excellent performance, durability and safety

